

Tinytag Ultra Radio Data Logger for PT1000 Probe (-200 to +100°C)



Tinytag Ultra Radio data loggers are a range of wireless data loggers products designed for indoor use. The loggers are used as part of a Tinytag Connect system that forms a robust data network that allows a user to see the conditions within an application from their own desk, across a LAN or the Internet.

Housed in a discreet case, the TR-3201 is a data logger that is ideal for unobtrusive low temperature monitoring in a variety of applications.

Features

- Low temperature monitoring
- Robust data network
- Easy to install
- Alarm e-mails
- 200m typical range (line of sight)
- High accuracy and reading resolution
- 12 month battery life
- Low battery monitor
- User-replaceable battery

Popular Applications

For low temperature monitoring in:

- Industry and warehouses
- Laboratories and research
- Freezers and Cryogenic applications

Tinytag Ultra Radio Data Logger for PT1000 Probe (-200 to +100°C)

How the Logger Works

The TR-3201 is a battery powered, temperature radio data logger.

The data logger is used with a PT1000 probe that is suitable measuring temperatures down to -200 °C.

The logger is used as part of a Tinytag Connect system that requires a receiver and the Connect version of the Tinytag Explorer software.

After the installation of the software and the configuration of the receiver, the logger is turned on and will establish itself as part of the mesh network the system creates.

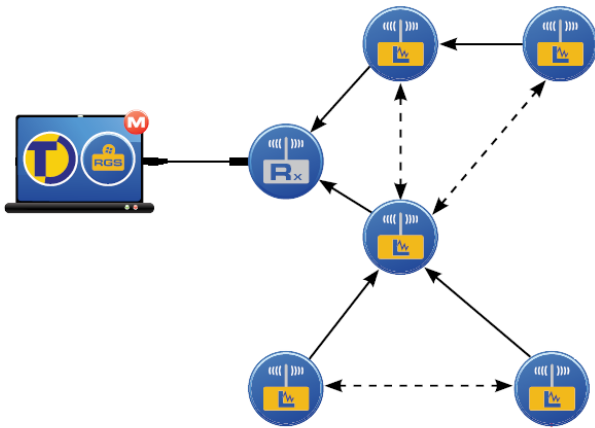

The typical range of the logger on a clear line of sight is 200m.

The logger is then set to record at a user-defined logging interval, anything from once every 2 minutes to once every 10 days.

The data recorded by the logger is stored on the computer running the system by a Windows service (called the radio gateway) and this is then viewed across a LAN or the Internet through the Tinytag Explorer Connect software.

If a logger cannot communicate with the mesh network for any reason, it will record locally until communications are restored.

The logger can be programmed with alarms. Warning e-mails can be sent when the limits entered are exceeded.

Data recorded by the system can be viewed as a graph or as a table of readings. There are also summary views containing information about the recording run and a daily min/max view.

Data from multiple devices recording at the same time can be combined into a single graph using Tinytag Explorer Connect.

Data can be exported from the software as a graph image, for use in report writing, or as a data table, for further analysis in third-party spreadsheet programs.

Features

Logging Interval	2 minutes to 10 days
Off-line storage Capacity*	2 weeks typical, at a 10 minute logging interval

Data loggers can be set to record in intervals of once every 2 minutes or greater (by default the logging interval is set to once every 10 minutes).

When radio communications are good, data is transmitted immediately and stored by the gateway service.

When communications with the gateway service are interrupted, by a power failure to the computer running the gateway service or an obstacle causing a blockage in radio communications, data loggers will record locally and then transmit data when communications are restored.

The off-line storage capacity of a data logger, for any given logging interval, is stated at the bottom of the configuration page for the logger in the Tinytag Explorer Connect software (this will be a minimum of 2 weeks when set to record at the default 10 minute logging interval).

*The local storage capacity of the logger is an indication of how much data the unit can record when it is unable to communicate with a receiver.

Alarms	2 fully programmable, latching alarms
Alarm Delay	1 second to 10 days

Loggers can be programmed with alarm limits that will cause warnings to be shown in Tinytag Explorer Connect and to make the units LED flash red.

Two alarm limits can be programmed per channel, allowing upper and lower boundaries to be set.

Delays can be set on the alarms so that routine tasks, such as restocking a fridge of freezer, can be performed without causing alarms to be activated.

E-mail warnings can be sent when alarm limits are breached, and these in turn can be used to send SMS messages using third party messaging services.

Radio Specification

Radio Frequency	EU	869.88MHz (-A part numbers)
	AUS	917.8MHz (-B part numbers)
Radio Power	EU	<5mW (-A part numbers)
	AUS	<3mW (-B part numbers)
Radio Range		200m, typical (line of sight)
Radio License		SRD licence-free

The logger uses FSK modulation, with +/-32 kHz deviation.

These frequencies will easily penetrate most internal walls, but the range may be reduced to between 30% and 80% (however it will sometimes be increased, maybe up to double the nominal range, due to reflections off walls and roofs etc.).

Although the radio waves cannot penetrate a metal wall (fridges or corrugated iron sheds etc.) the signal will often still get through gaps around door seals, windows and air vents etc.

These frequencies are very slightly absorbed by water. Wet walls are not a problem, but the signal will not get through a room filled with shelves full of fruit or bottled water, for example.

The advantage of the mesh network, though, is that loggers in locations with shorter ranges will often be able to relay data through other loggers that are able to transmit further.

Tinytag Ultra Radio Data Logger for PT1000 Probe (-200 to +100°C)

Reading Specification

Temperature

Reading Range	-200°C to +100°C
Sensor Type	PT1000 (external probe, 3-wire)
Logger Resolution	0.01°C or better
Temperature Stability	±0.01°C/°C change from 25°C
Logger Accuracy	

The graph below is the accuracy of the TR-3201 when used with a PB-7002 probe. Using a different probe may effect the accuracy of the unit.

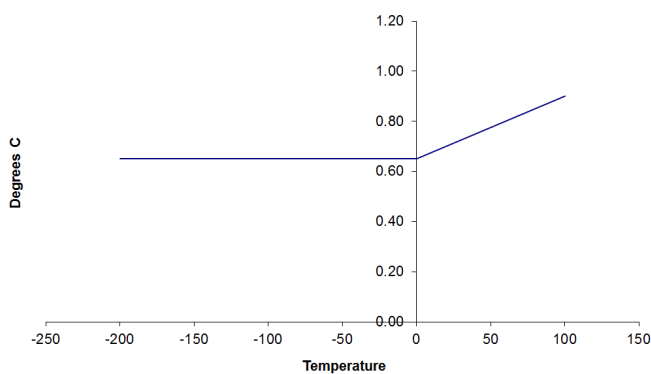

Connections

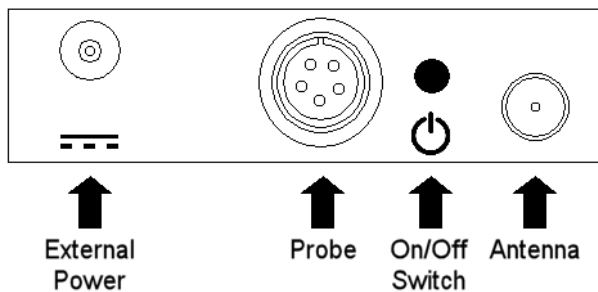

Physical Specification

IP Rating	IP20
Operational Range*	-20°C to +55°C
Case Dimensions (excluding antenna)	
Length	121mm / 4.76"
Width	79mm / 3.11"
Depth	24mm / 0.94"
Weight (inc. antenna)	180g / 6.35oz

*The Operational Range indicates the physical limits to which the unit can be exposed.

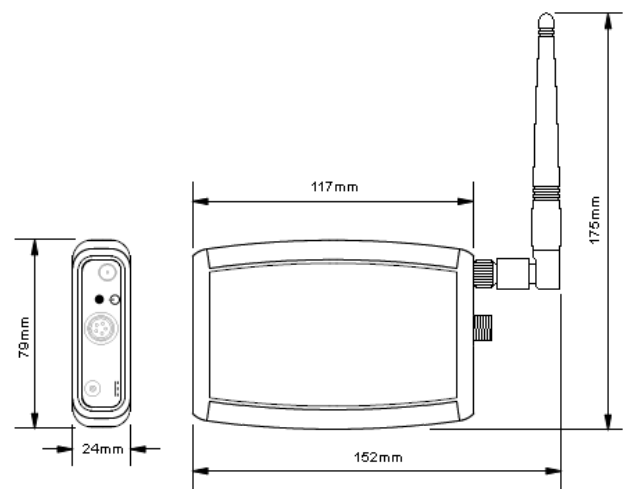

Mounting



The logger is supplied with a bracket for easy wall mounting.

This comes in two parts; a bracket that screws onto the wall and a clip that screws into the logger. When fitted, the clip slots into the bracket.

The two mounting holes on the bracket are 3mm in diameter and 32mm apart.

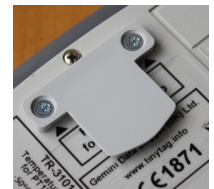

The logger can also be positioned on a non-conductive flat surface, such as a desk or a shelf, with its antenna positioned vertically, with no loss of performance.

Tinytag Ultra Radio Data Logger for PT1000 Probe (-200 to +100°C)

Power Information

Battery Power

Battery Type 2 x Duracell Industrial ID1500
AA (LR6) 1.5V (supplied)

The logger will operate with other AA batteries but performance cannot be guaranteed.

Battery Life Typically 12 months

When the logger's batteries start to run flat, a low battery warning will be displayed in the Tinytag Explorer Connect software and the LED on the front of the logger will flash red. The low battery warnings will start to flash when the logger has approximately two weeks of battery power remaining.

Before replacing batteries the logger must be turned off.

Alkaline batteries should always be replaced in pairs.

Data stored in the radio system will be retained after batteries are replaced.

Mains Power

The logger can also be powered from the mains using a plug-in power supply.

If the power supply is interrupted, the logger's batteries will power the logger and continue recording until the supply is restored.

Note: This logger should only be used with an ACS-0005 Tinytag power supply.

Notes

Apart from the battery enclosure, this data logger contains no user-serviceable parts and should not be opened.

Calibration

This logger is configured to meet Gemini's quoted accuracy specification during its manufacture.

We recommend that the calibration of this unit should be checked annually against a calibrated reference meter.

A traceable certificate of calibration can be supplied for an additional charge either at the point of purchase, or if the unit is returned for a Service Calibration.

Warranty

This product carries a manufacturing defects warranty of 12 months from the date of purchase. Units returned under warranty will be repaired or replaced at the manufacturer's discretion. This warranty does not cover mishandling, modification or battery replacement and is subject to our standard Terms and Conditions of Sale, a copy of which can be found at www.tinytag.info.

Approvals

Gemini Data Loggers (UK) Limited hereby declares that this radio data logger is in compliance with the essential requirements and other relevant provisions of RED 2014/53/EU and RoHS directive 2011/65/EU. A copy of the declaration of conformity is available upon request.

The radio system also complies with EN 300 220:V2.4.1 and EN 301 489-3: V1.6.1 (-A EU version) and AS/NZS 4268:2012 (-B AUS version).

This logger also conforms to the following EMC standards: EN 55032:2012; EN 61326-1:2013 & EN 301 489-1:V1.9.2.

Gemini Data Loggers (UK) Ltd. operates a Business Management System which conforms to ISO 9001 and ISO 14001.



Required and Related Products

Required Parts

This data logger forms part of a Tinytag Connect system and cannot be used as a standalone device.

To use this data logger you will require a radio receiver and a Connect version of the Tinytag Explorer software. These are supplied together in a pack, as follows:

ACSR-3030-PK Ultra Radio Receiver Pack

Probes

You will also require one of the following probes:

PB-7002-1M5/3M Standard PT1000 Probe (-200 to +100°C) or
PB-7003-1M5/3M PT1000 Freezer Probe (-80 to 100°C)

Further Related Products

ACS-0005 Power Supply for Ultra Radio